

# ACORD Life Reference Hierarchy - Version 2.27.90

Please note, objects are arranged according to function in order to ease finding related items.

**TXLife**



TXLifeRequest



TXLifeResponse



TXLifeNotify



**OLife**

**XTbML**



SourceInfo

**Activity**



**AuditEntry**



**BusinessProcessDef**



**Campaign**



**Case**



**CodeList**



**CommSchedule**



**Currency**



**DistributionAgreement**



**FinancialStatement**



**FormInstance**



**Grouping**



**Holding**



**InvestProduct**



**Party**



**PolicyProduct**



**Relation**



**Scenario**



**SettlementInfo**



**SystemMessage**



**UnderwritingGuidelines**



# ACORD Life Party Reference Model - Version 2.27.90

## Party

Please note, objects are arranged according to function in order to ease finding related items.

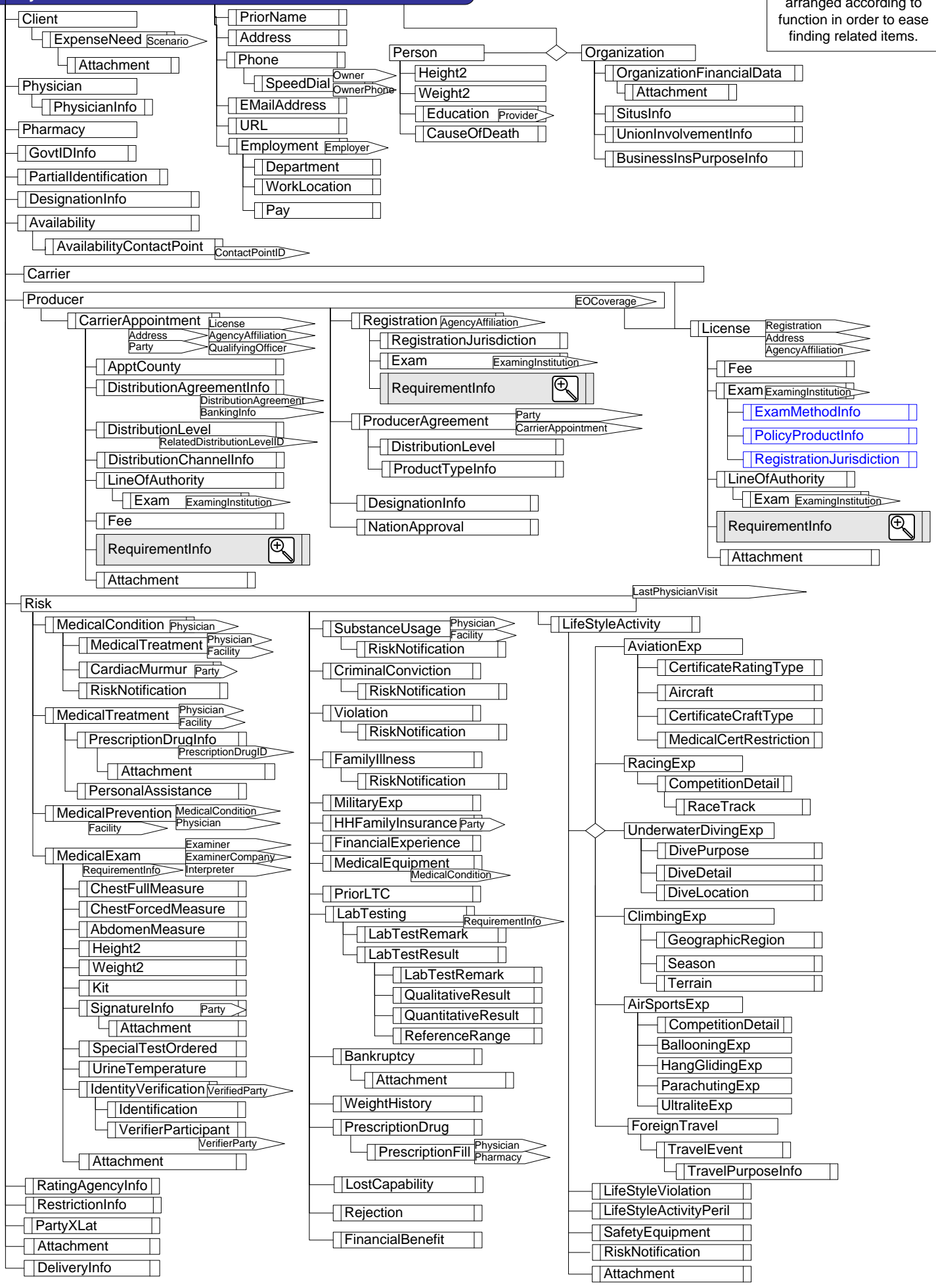

# ACORD Life Holding Reference Model - Version 2.27.90

Please note, objects are arranged according to function in order to ease finding related items.

## Holding

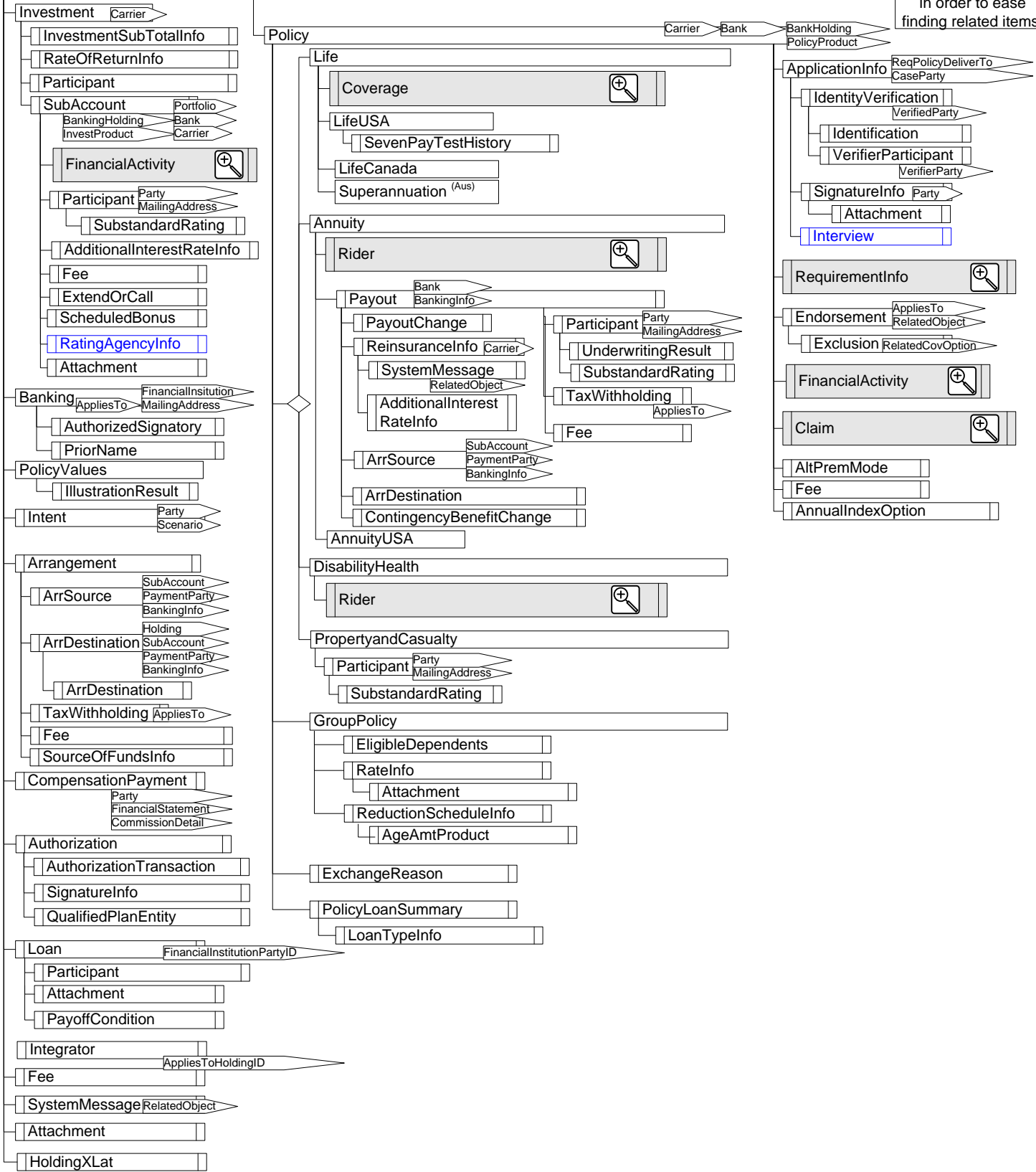

# ACORD Life PolicyProduct Reference Model - Version 2.27.90

## PolicyProduct

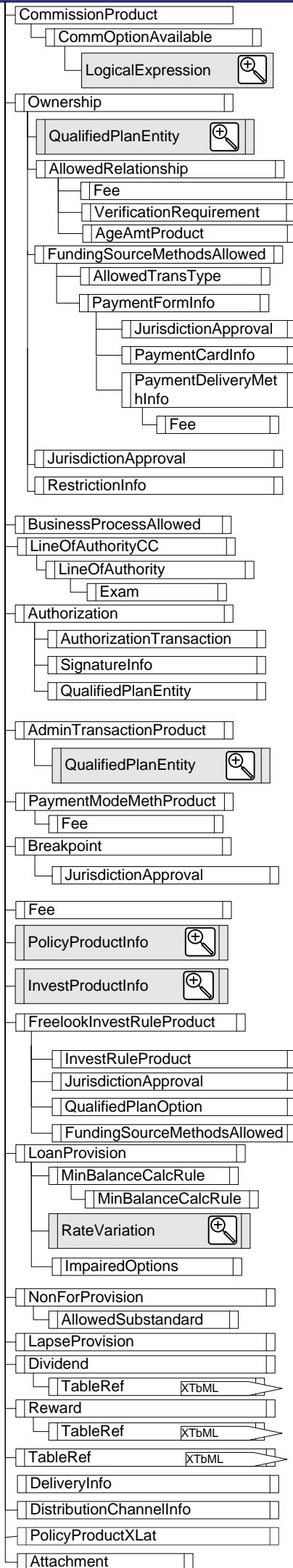

Party  
UnderwritingGuidelinesID

Please note, objects are arranged according to function in order to ease finding related items.

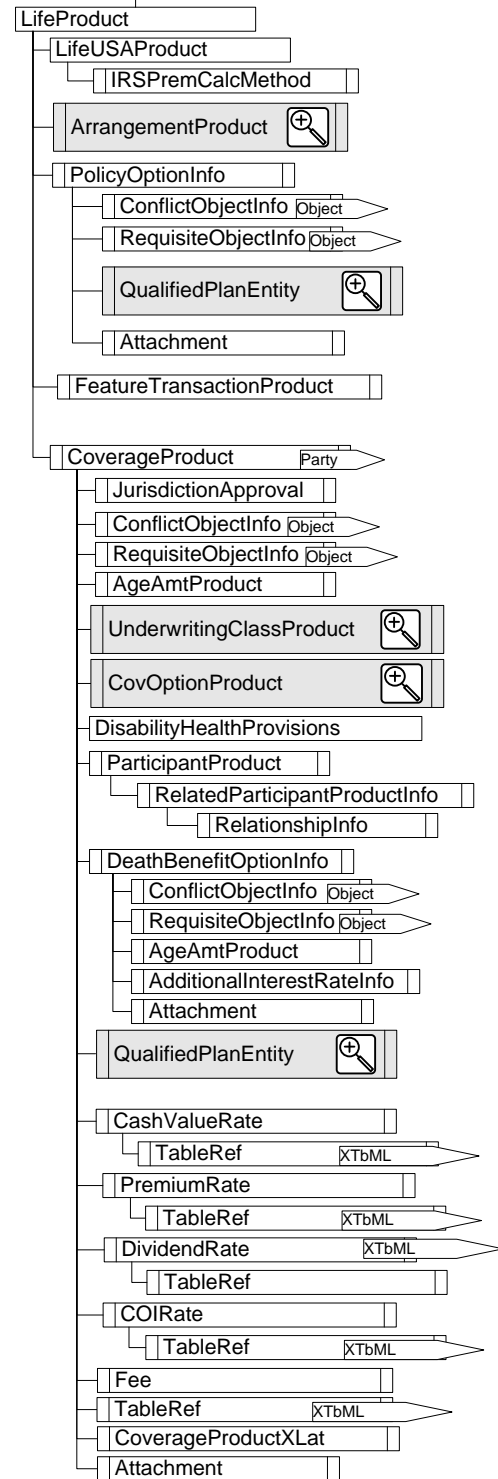
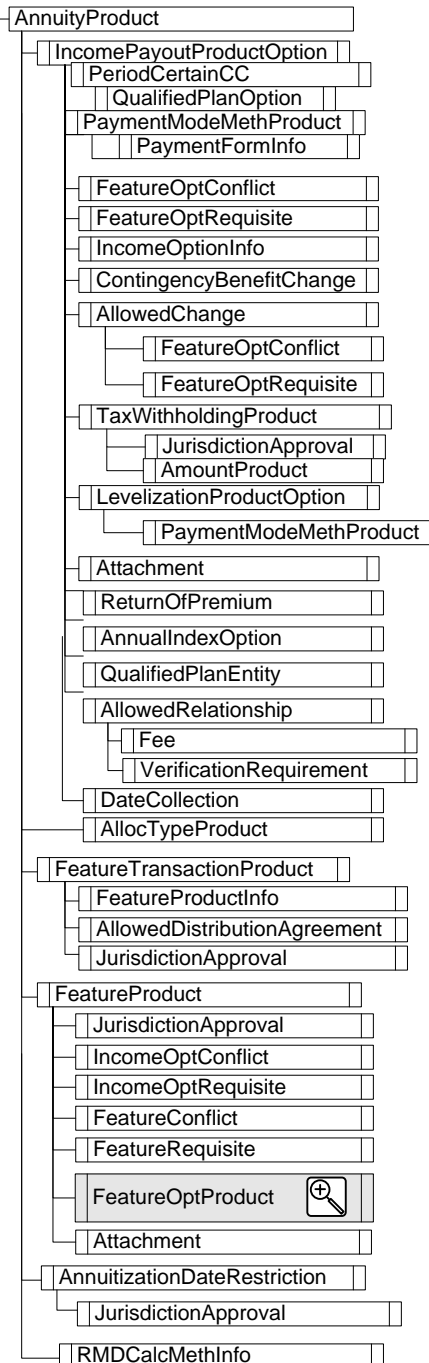
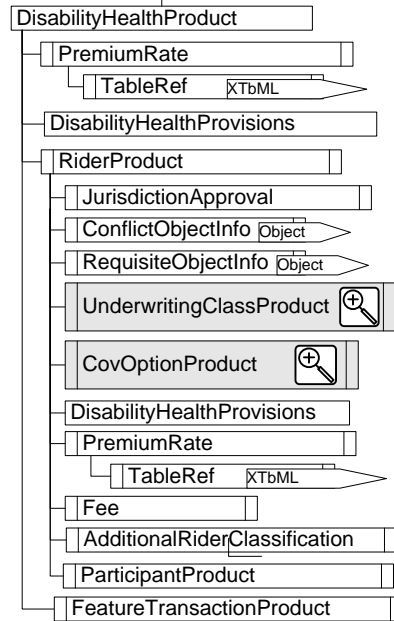

# ACORD Life FinancialStatement Ref. Model - Version 2.27.90

Please note, objects are arranged according to function in order to ease finding related items.

## FinancialStatement

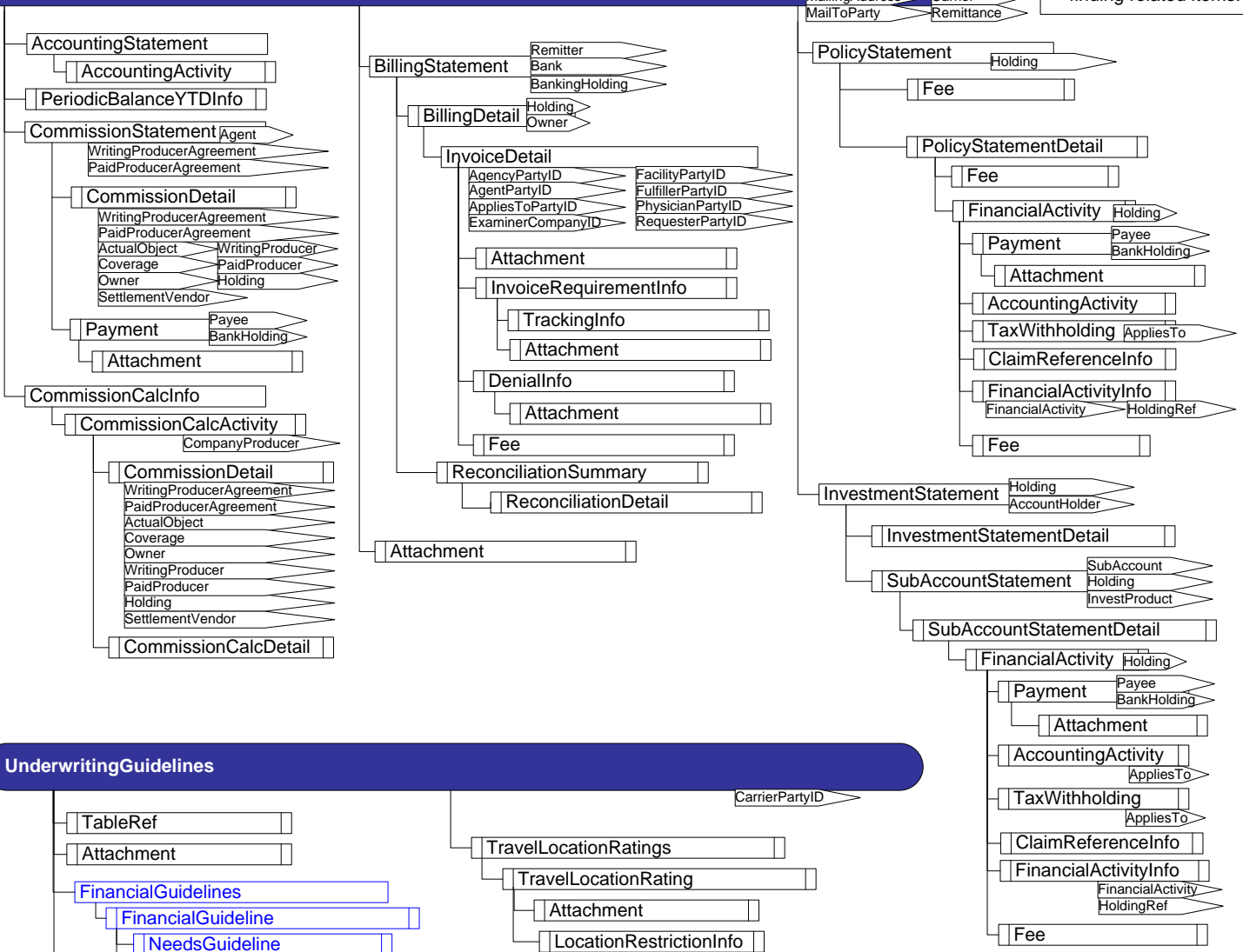

## UnderwritingGuidelines

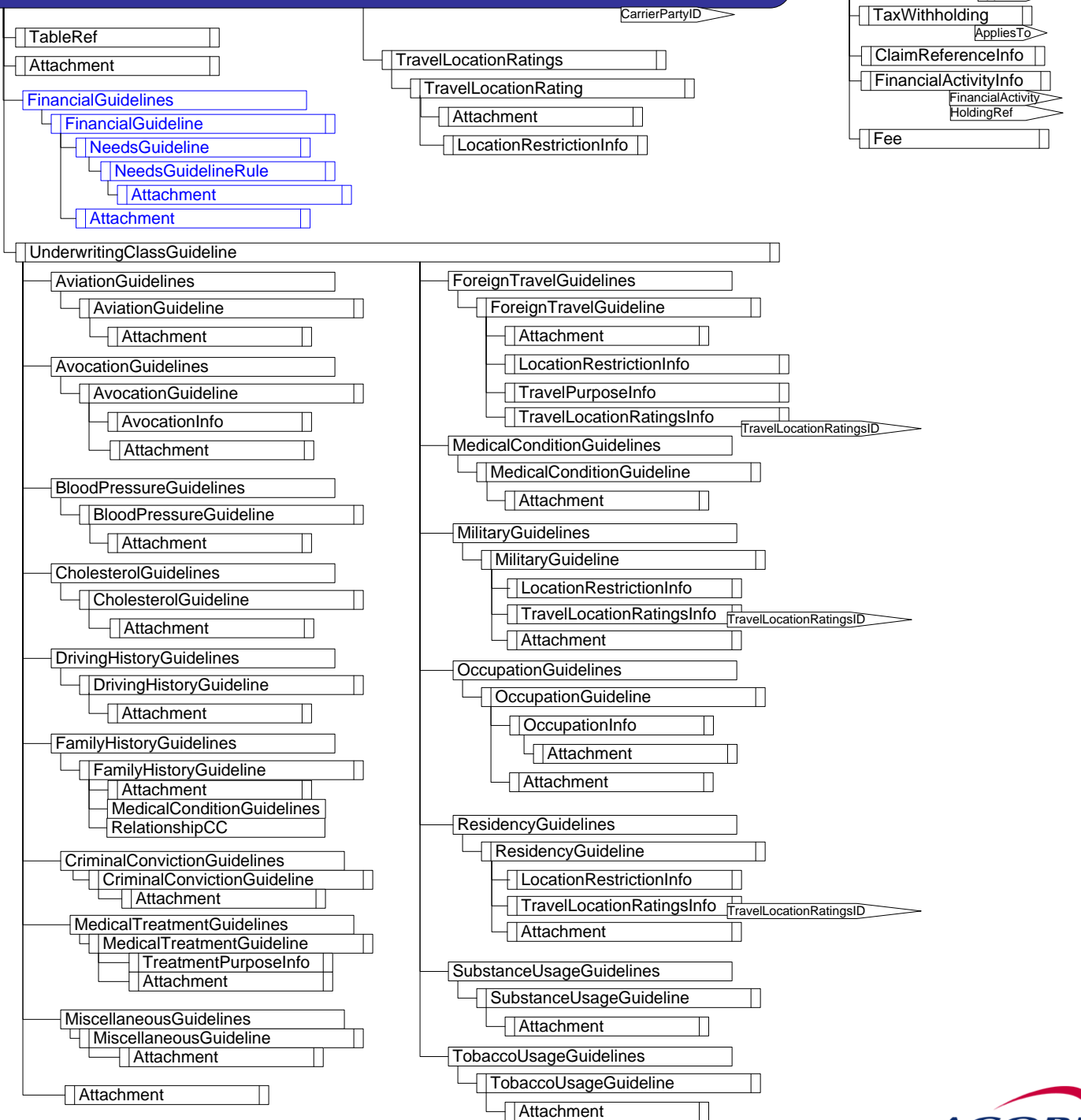

# ACORD Life Misc. Objects Reference Model - Version 2.27.90

Please note, objects are arranged according to function in order to ease finding related items.

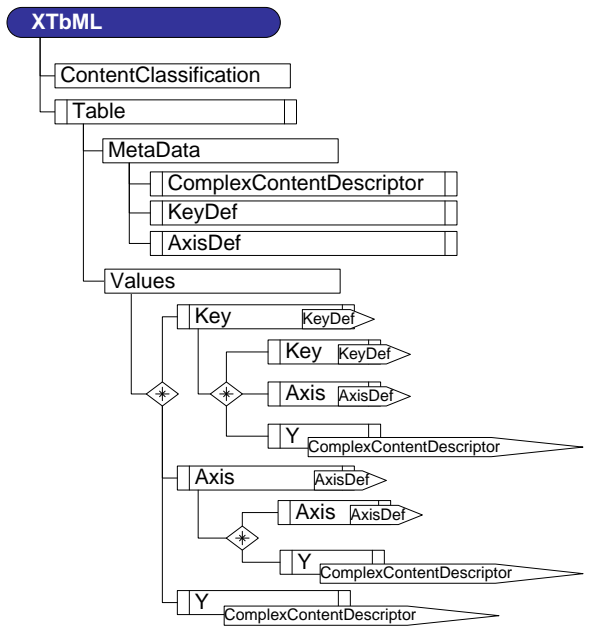
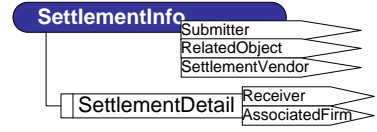
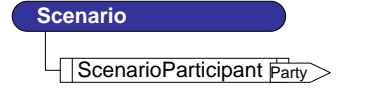
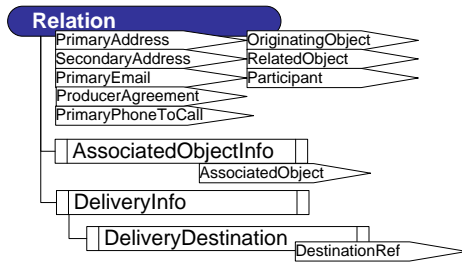
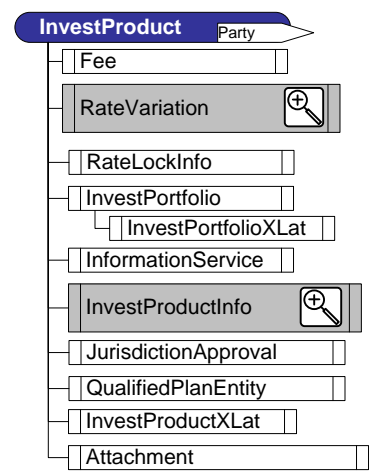
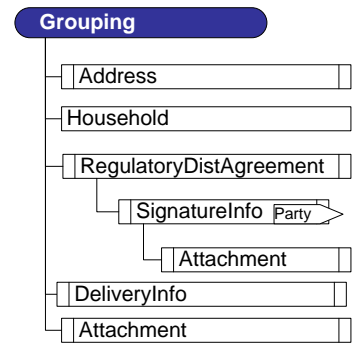
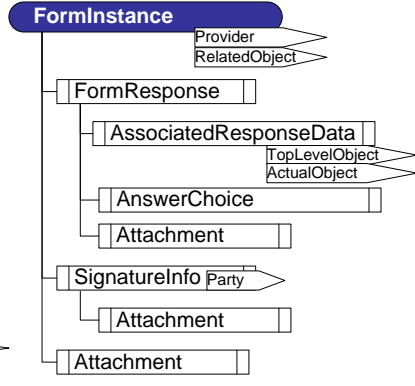
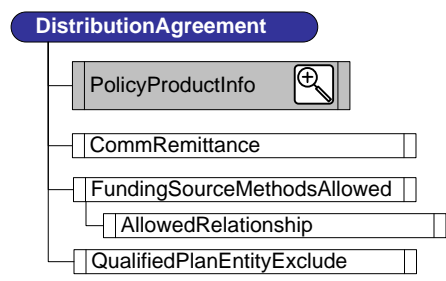
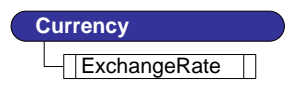
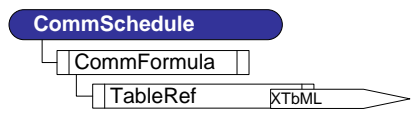
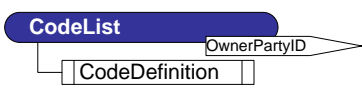
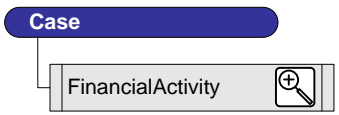
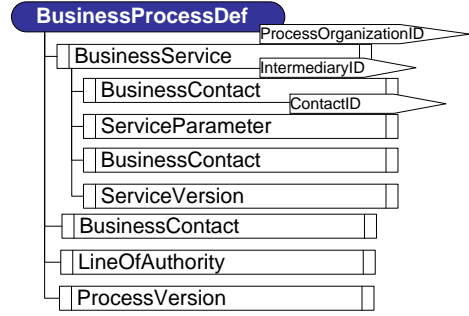
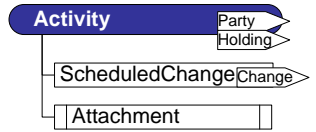
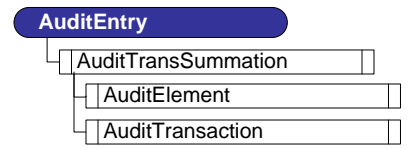

# ACORD Life Transaction Reference Model - Version 2.27.90

Please note, objects are arranged according to function in order to ease finding related items.

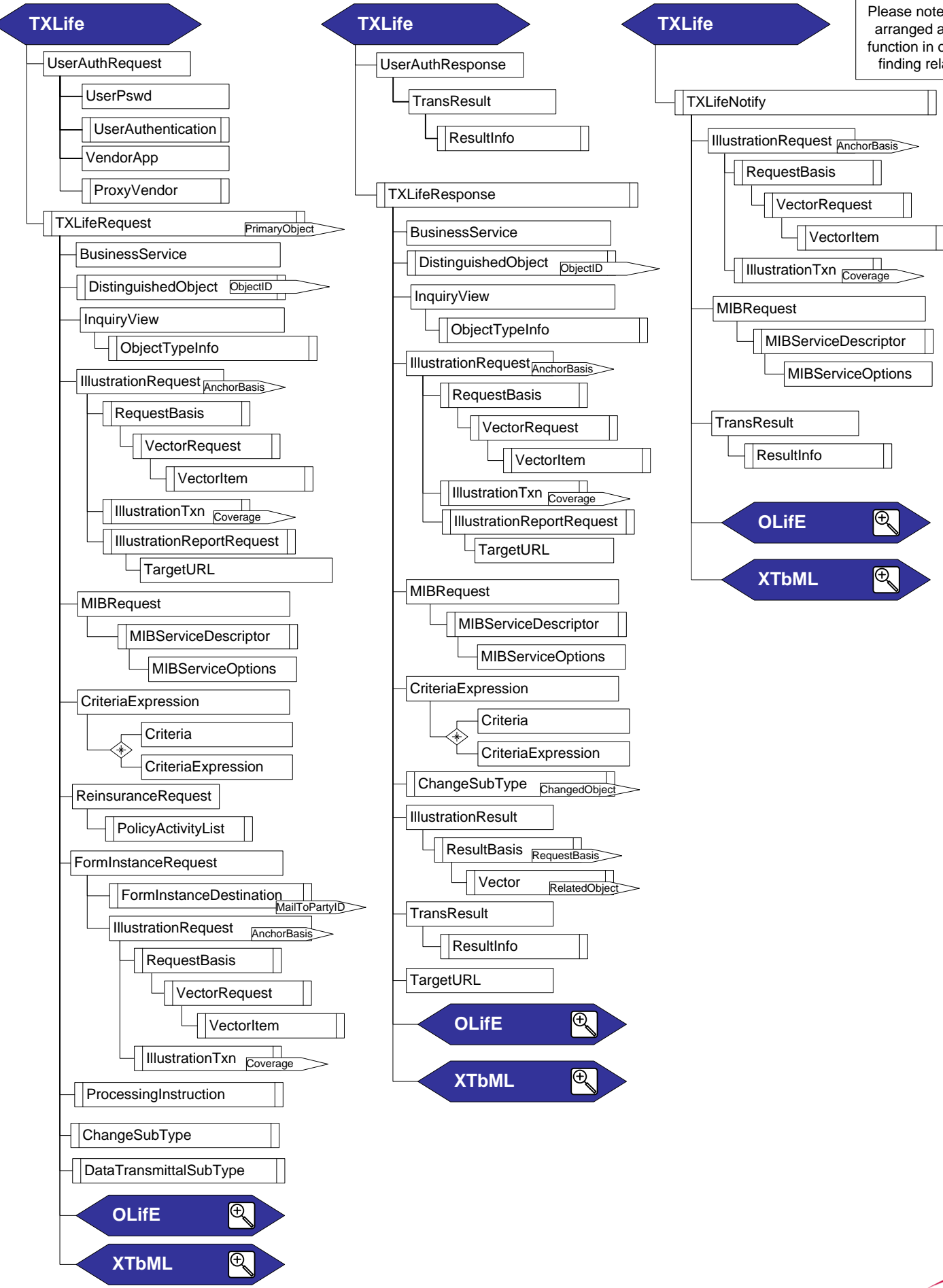

# ACORD Life Support Objects Model - Version 2.27.90

Please note, objects are arranged according to function in order to ease finding related items.

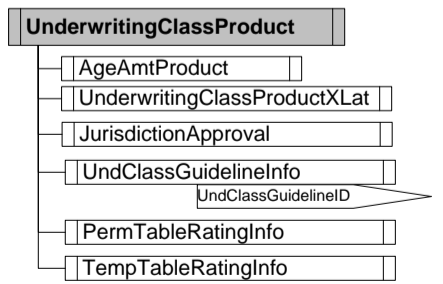
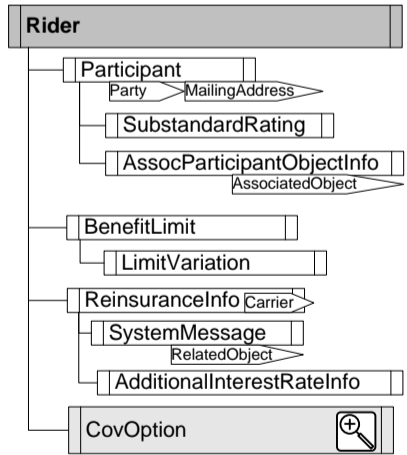
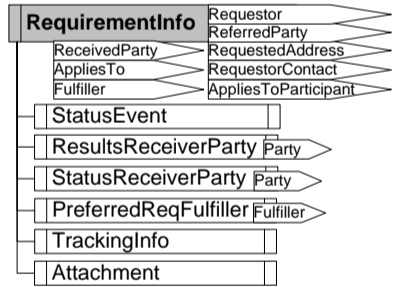
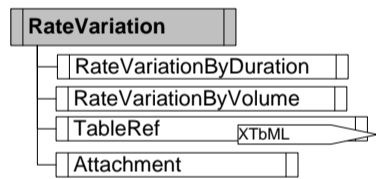
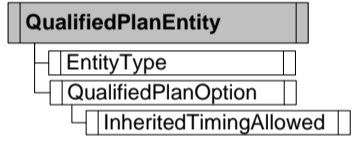
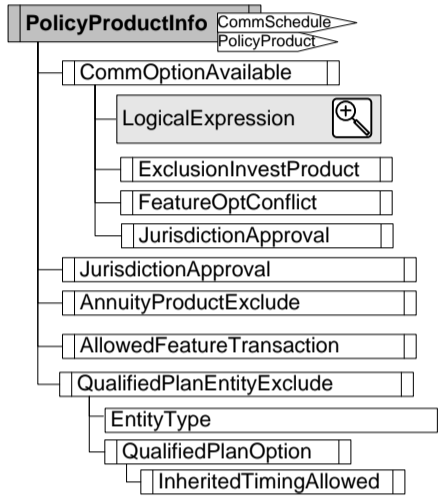
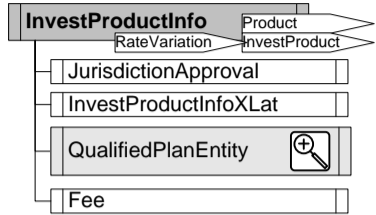
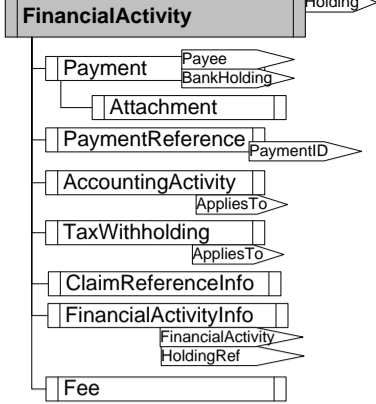
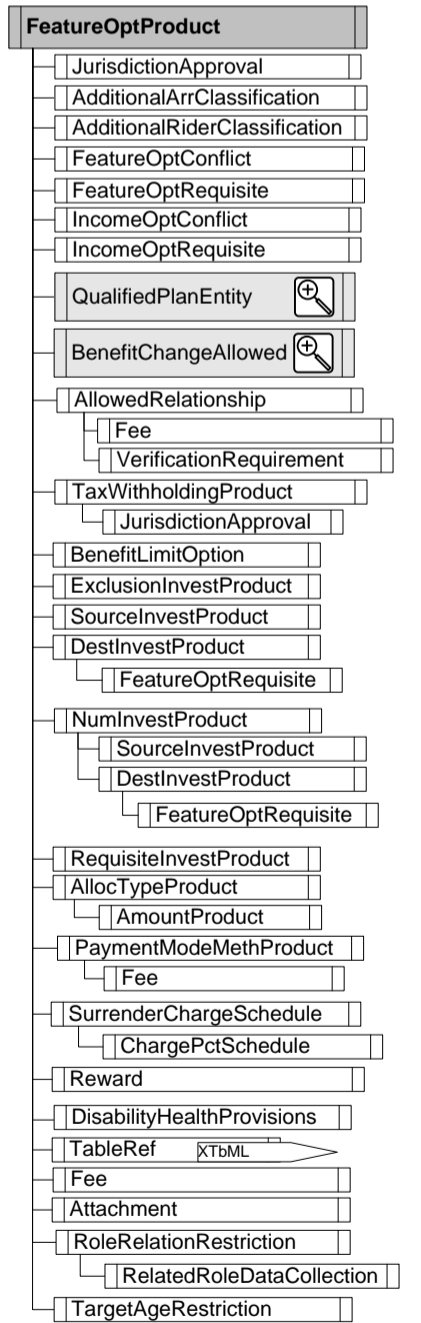
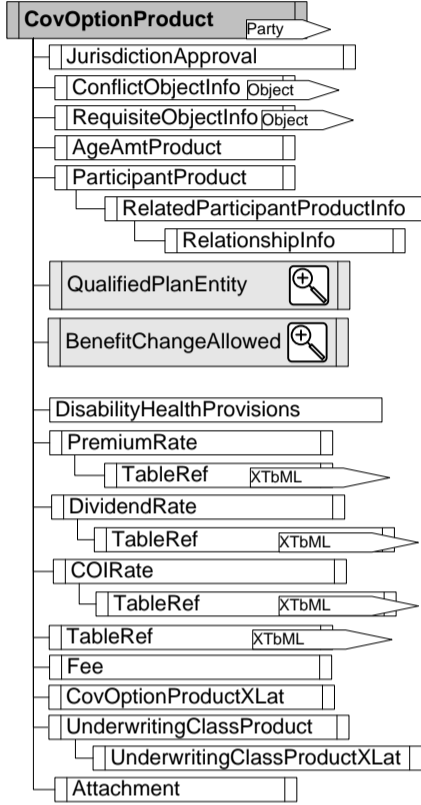
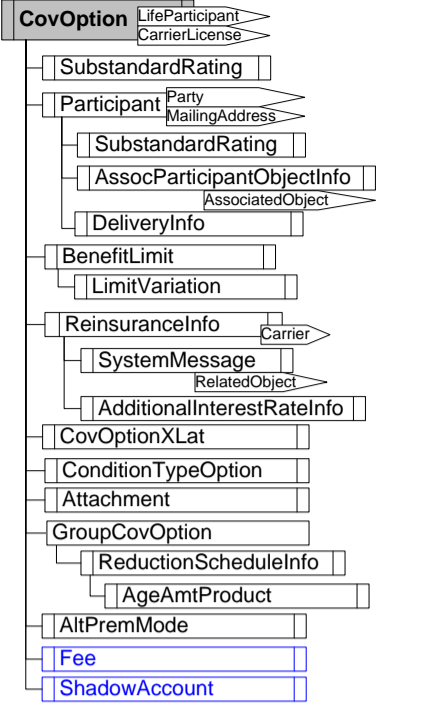
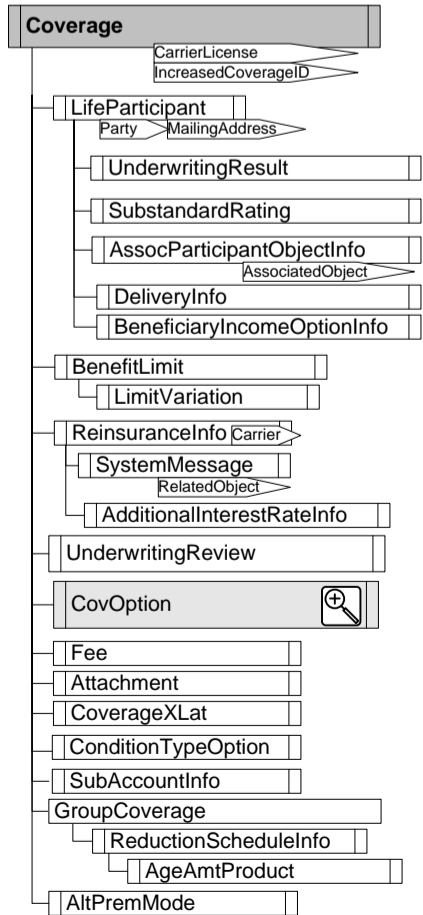
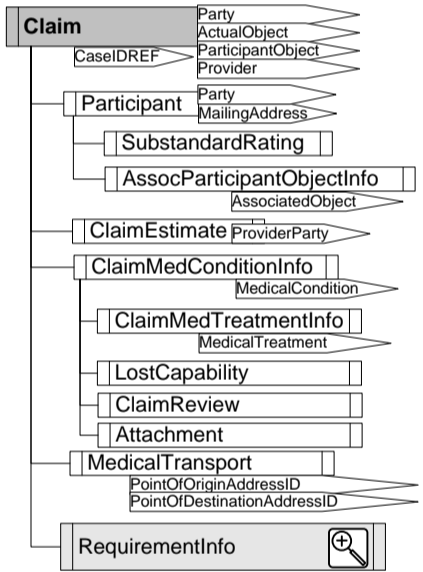
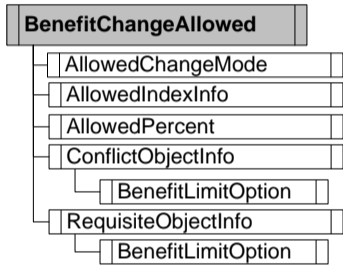
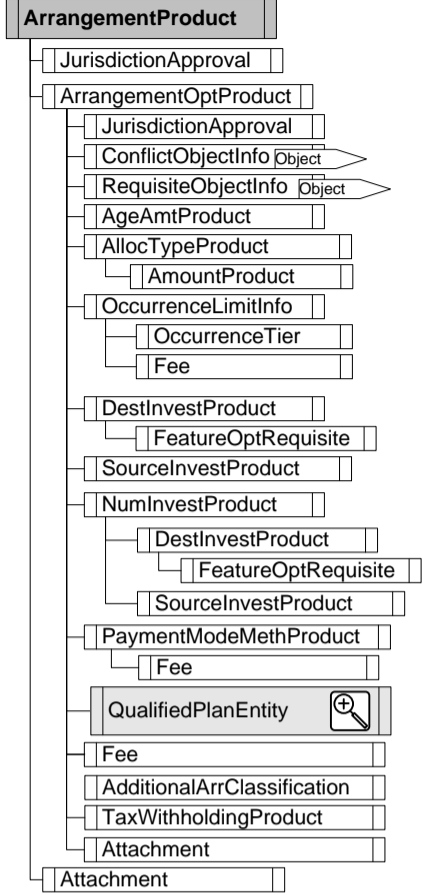
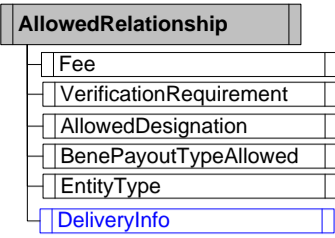



# ACORD Life Hierarchy Reference Legend - Version 2.27.90

## Root Element

A Root Element is an Object/Aggregate (see *Single Object Occurrence* below). However, a Root Element may also be used as the sole XML Document in an ACORD Life Message. For more information, refer to the Table of Contents for the section titled *Root Elements*. For an explanation of XML Documents, please refer to the W3C XML Standard.

See also: [Root Elements](#) [W3C Document Definition](#)

## Top-Level Object

A Top-Level Object is an optional, repeating aggregate that is a direct child of the <OLifE> element. Top-Level aggregates are unique in that they require an @ID attribute and may be related using the <Relation> aggregate.

See also: [<Relation>](#) [<OLifE>](#)

## Single Object Occurrence

This symbol is used to represent an object/aggregate that is not allowed to repeat.

## Object Collection

This symbol represents an object that is allowed to repeat. This is also known as an Object Collection.

## Foreign Object Reference

Represents an IDREF attribute that references another aggregate. For more information, refer to the table of contents for the section titled *How to handle Object IDs*.

See also: [How to handle Object IDs](#) [W3C ID Definition](#) [W3C IDREF Definition](#)

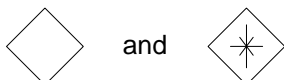

and

These symbols are used to indicate a choice. That is, only one of the indicated child aggregates may appear in the XML. The difference between these two is that the one with the star in the middle (on the right) represents a repeating choice.



This is an “off-page” indicator that is used to represent the hierarchy of the associated object are not shown. In the Help File, clicking on this indicator will open the page containing the rest of the aggregate’s hierarchy.

## Blue = New to this Release

Elements that appear blue in the hierarchy pages are new to this version of the ACORD Life Standard.